

Varenummer: 2301078926
Beskrivelse: E+G Håndhjul
VRTP.250+IEL-A20

Mål

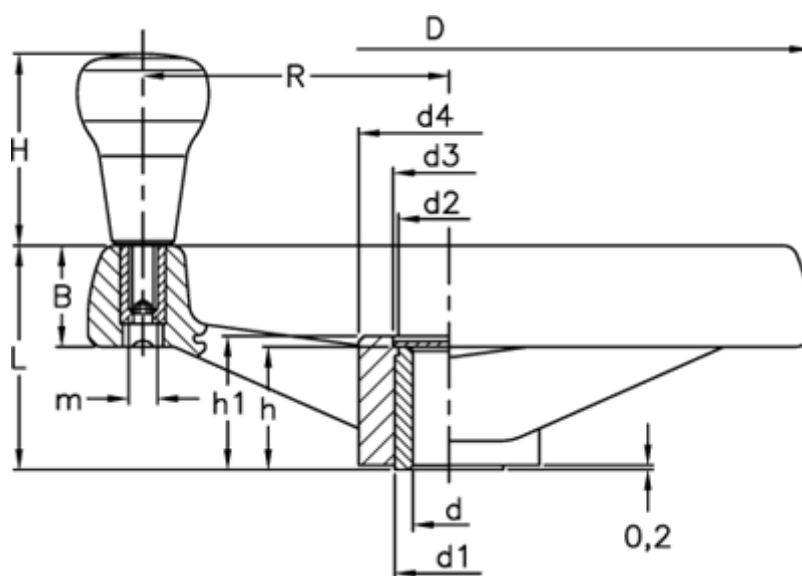

B	= 32	H	= 65
C (N*m)	= 420	h	= 38
D	= 249	h1	= 40
d1	= 35	L	= 70
d2	= 33	L (J)	= 28
d3	= 34	m	= M10
d4	= 59	R	= 105
d H7	= 20		